

Pareto

Aluminum Systems









ALFOTM

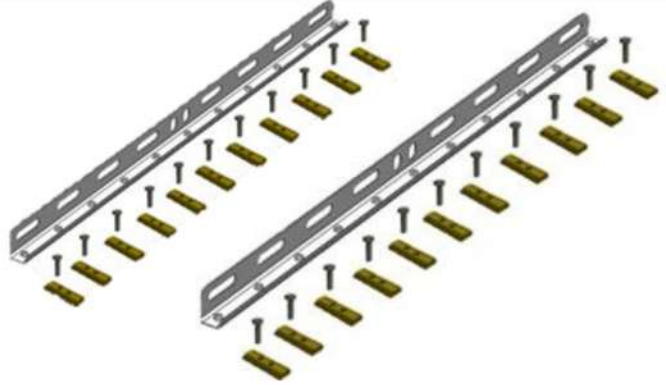

Aluminum Flooring System

www.paretoas.com

ALFO 3.0 Installation Guide



#	Description	Picture	#	Description	Pictures	
1	3/8" Allen key for 3/8"-16 - Bolt		4	Alignment Hangers 2 Sets		
2	Standard 3/8" Drill Bit Special 3/8" x 8" Drill Bit		5	Gerflor Template	 Trimming Template for Gerflor	
3	Drill Drive		6	Scissor & Utility Knife	 	

These items are not included in the package

#	Description	Picture
7	Sealant Gun	
8	Sikaflex 255 FC	
9	Sika Aktivator-205	

These items are not included in the package

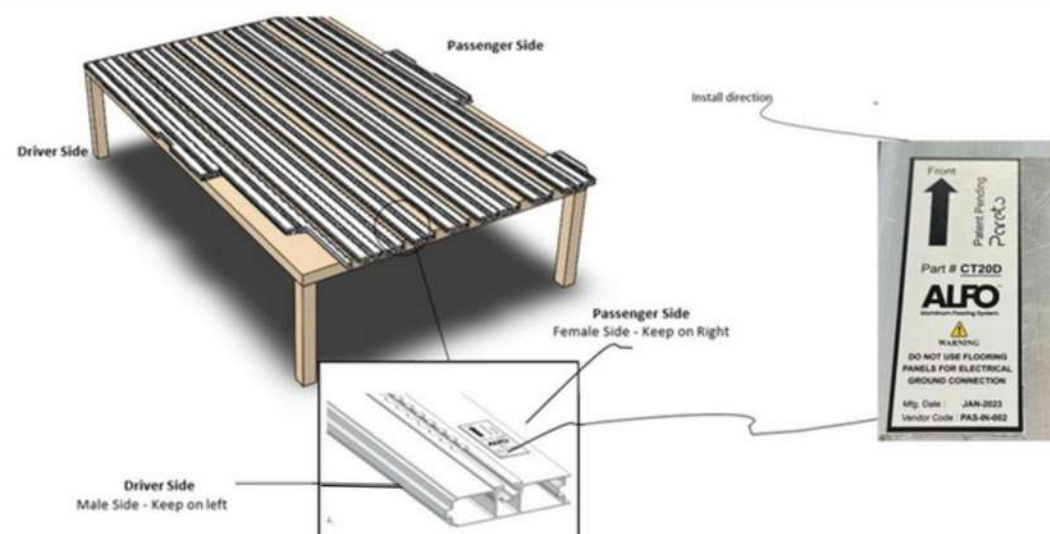
Sikaflex and Sika Aktivator -205 have a 9 month expiration date. Please purchase and use accordingly.

#	Install Step	Description of the steps	Pictures
1	Unbox the Crate and place the Panels on a Worktable	<ul style="list-style-type: none"> Check all panels availability as per the kit BOM available on the website. https://paretoas.com/alfo-kits/ Each panel has a unique part # printed on the label. Arrange the panels on table as per required configuration (refer page #09-#19 i.e, fig1.1- fig1.12) 	
2	Attach ALFO spacers (If required by the floor)	<ul style="list-style-type: none"> Apply Sikaflex 255 FC to attach ALFO spacers (Aluminum) at the location shown in the picture using the Sealant Gun. Compress the Sikaflex 255 FC until the top surface of the spacer aligns with the top surface of floor ribs on the van floor. Ensure that the ALFO spacers are levelled with the floor ribs on the chassis floor. 	

Glue is not included in the package

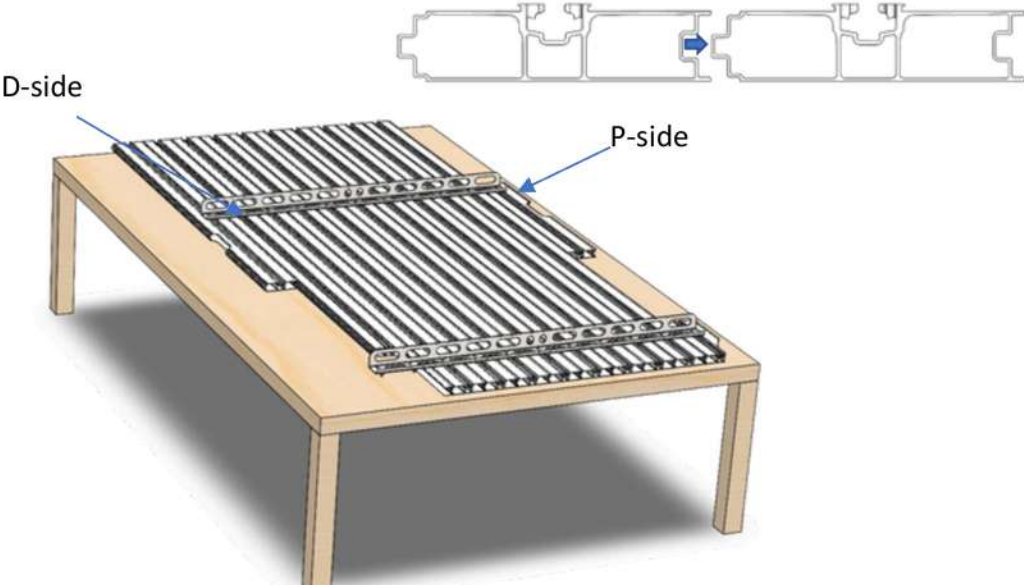
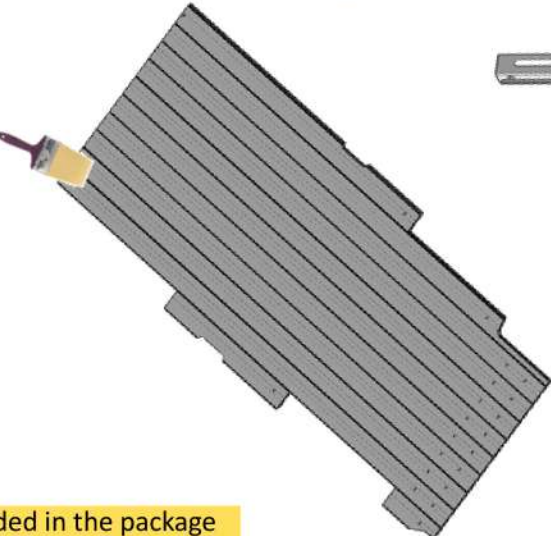
#	Install Step	Description of the steps	Pictures
3	<p>Connect the 12 Panels as Shown. Use Hangers to Align the Holes on All Panels</p> <p>Ensure that the holes are aligned across panels. Pareto's flexible legs cannot be used if holes are not aligned.</p>	<ul style="list-style-type: none"> • Connect 12 panels starting from the passenger side (P-side), layout shown in page #09-#19 base on the type of kit(Fig 1.1-Fig 1.12). • Install the hangers with manual foot inside every L-tracks, this is important for aligning holes across panels • Ensure that the passenger side panel (PT) is installed in accordance with the dimensions shown in Fig 2.1- Fig 2.5 • Hangers not only aligns holes, but also keeps the panels together during installation and bolting in the van 	 <p>The diagram illustrates the assembly process. At the top, a cross-sectional view shows two panels being joined, with a blue arrow indicating the direction of assembly. Below this, a 3D perspective view shows a wooden table with 12 panels laid out on its surface. Two metal hangers are placed across the panels to align them. Labels 'D-side' and 'P-side' point to the respective ends of the panels. The word 'Hangers' is written next to a detailed view of a single hanger.</p>
4	Apply Aktivator	Tilt the floor and apply Sika Aktivator 205 on the bottom of ALFO floor as shown below using the paint brush.	 <p>The diagram shows a grey, textured floor panel being tilted. A paintbrush is shown applying a substance to the bottom surface of the panel.</p>

Alignment hangers and Sika Aktivator 205 are not included in the package

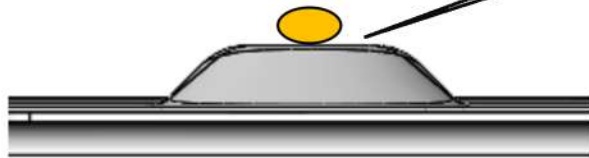
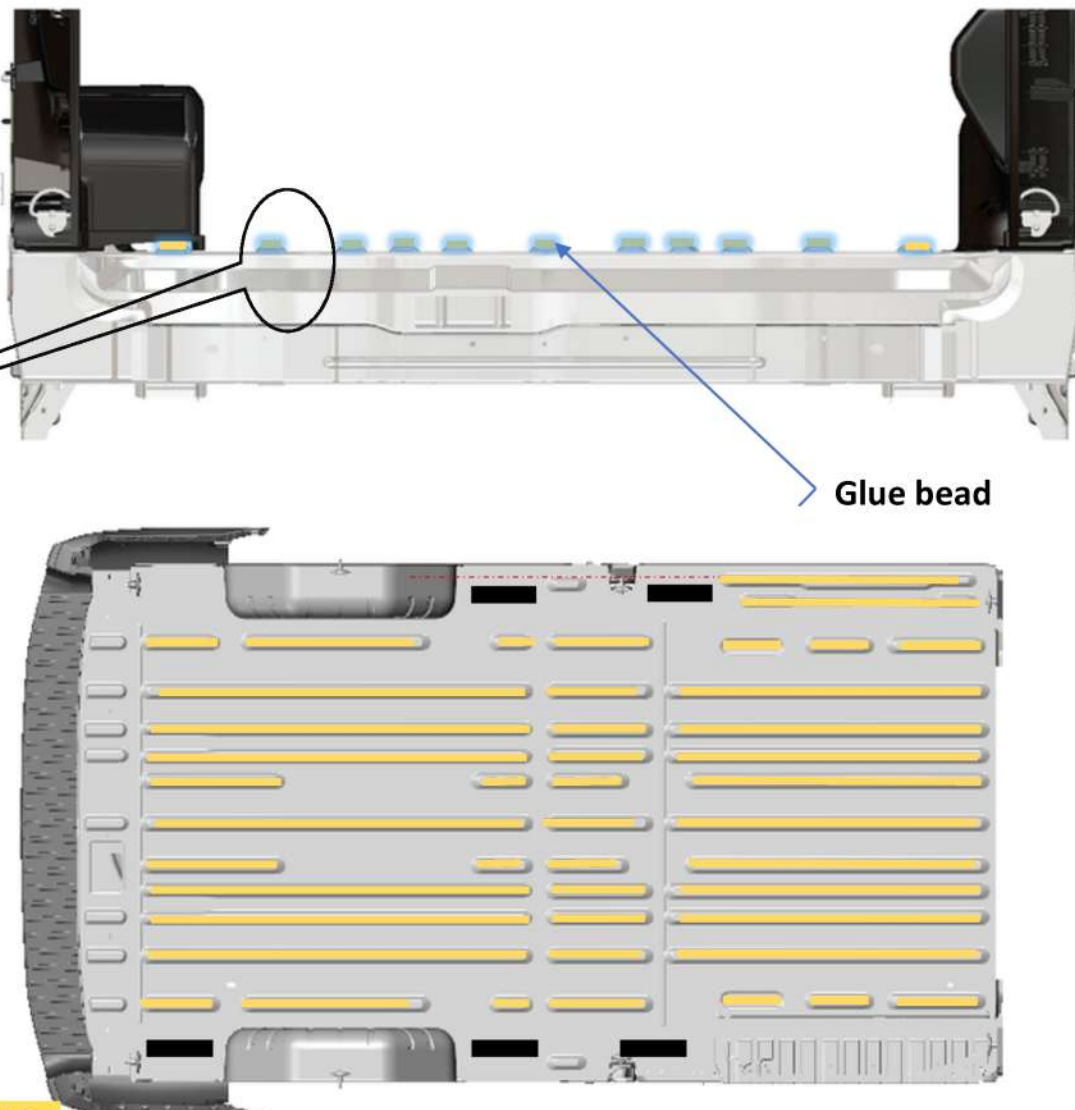
#	Install Step	Description of the steps	Pictures
5	Apply glue on vehicle floor	<ul style="list-style-type: none">Apply Sikaflex 255 FC on the ribs of vehicle floor as shown in picture throughout the length. 	 <p>Glue bead</p>

Sikaflex 255 FC is not included in the package.

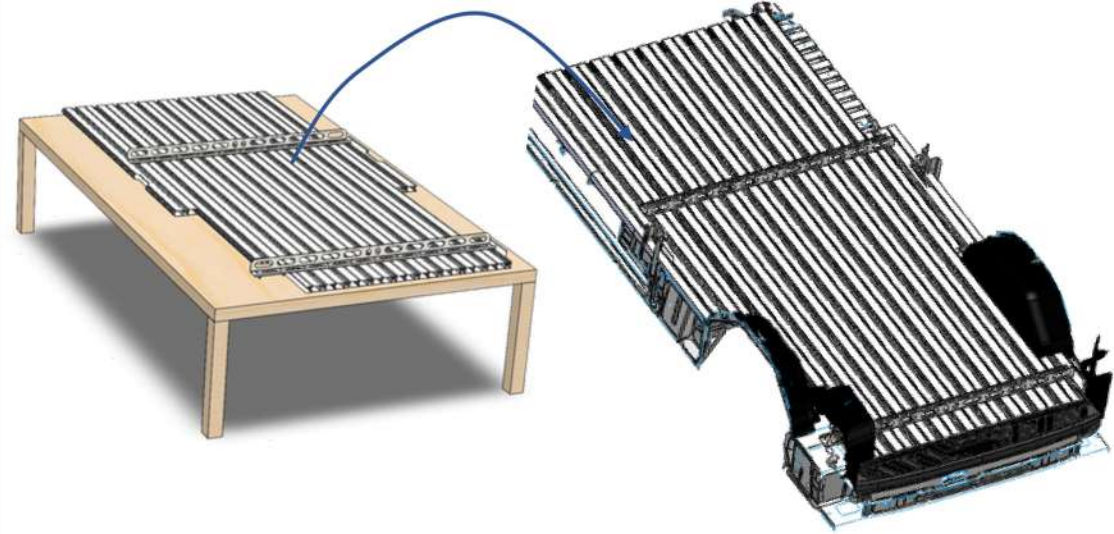
#	Install Step	Description of the steps	Pictures
6	Take the assembly with hangers in the van.	<ul style="list-style-type: none">• Lift the panel assembly , and put it inside the van• Ensure that there is enough space left on sides to install foam sticks and foam corners.• Adjust the forward and cross car direction as required.	



Pareto's flexible legs cannot be used if the holes are not aligned.

Alignment hangers are not included in the package

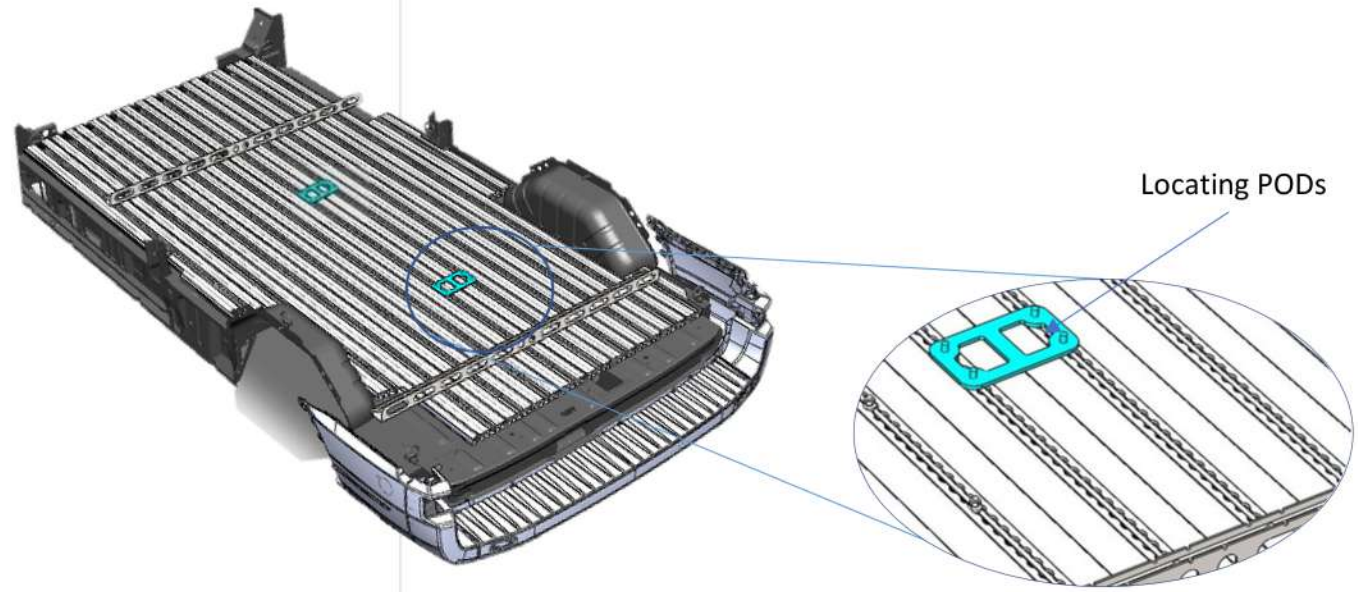
#	Install Step	Description of the steps	Pictures
7	Hole Alignment Inspection	<ul style="list-style-type: none"> Inspect the hole alignment with the locating pod at multiple places as shown. 	 <p>The diagram illustrates the hole alignment inspection process. It shows a perspective view of a truck chassis with a locating pod (a blue rectangular tool with four pins) placed on the chassis. A blue circle highlights the area where the pod is used. A magnified view of the pod on the chassis is shown to the right, with the label 'Locating PODs' pointing to it.</p>

 Pareto's flexible legs cannot be used if the holes are not aligned.

Locating POD's are not included in the package

#

Put the foam sides and foam corner as shown in the picture.

8 Fit With Foam



Use gloves while cutting the foam

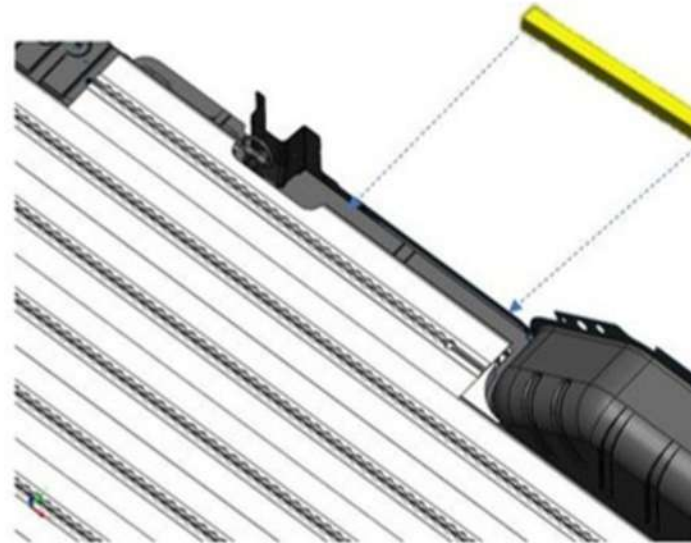

Use EPP foam of 3/4" to fill the gaps(included in kit)

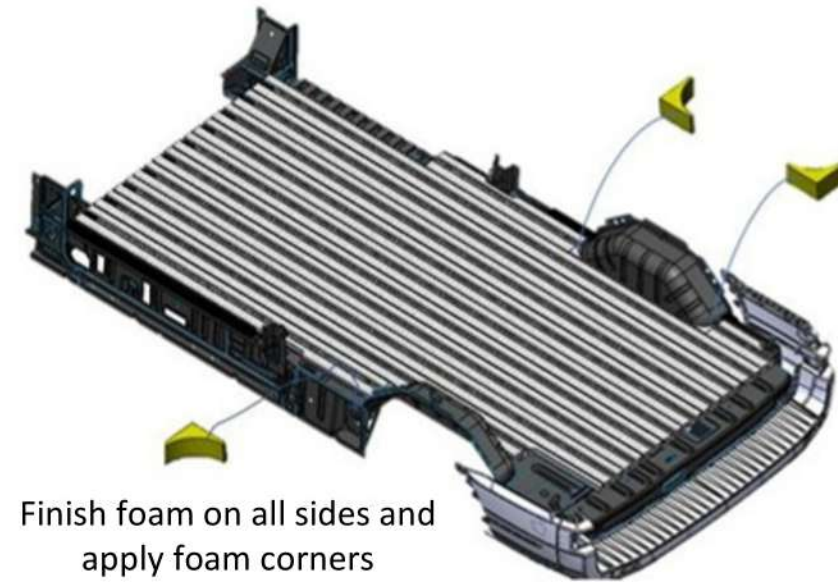

Finish foam on all sides and apply foam corners

#	Install Step	Description of the steps	Pictures
9	<p>Drilling, Bolting at the Rear</p> <p>Ensure that a bolt is inserted after drilling each hole. This helps to restrict the movement of the floor while drilling the next hole.</p> <p>Ensure that washer plate or double washers are used on the top and the bolts are tightened with a torque of 60 Nm</p>	<ul style="list-style-type: none"> Do not uninstall the hanger until step 8 is completed. Drill the OEM body using the through holes at the rear end of the panels. Based on the type of floor, use specific bolts length at specific locations as shown in page #09-#19 (fig 1.1- fig 1.11) Tighten the nuts with underbody reinforcement plates and washers. 	<p>Note :</p> <ol style="list-style-type: none"> For electric transit, self tapping screws should be replaced with glue, refer to page #22 (fig 3.1) For standard vans, use 1 qty of 7" bolts on the driver side front, refer to fig 1.1-fig 1.11
10	<p><u>Non-Electric Vehicles:</u> Use Only Self Tapping Screws.</p> <p><u>Electric Vehicles:</u> Use Only 2 Feet of Glue in the Front</p>	<ul style="list-style-type: none"> Use self tapping screws in the front of the panels as shown in the picture. Ensure that the head of the self tapping screw's sits inside the groove and does not come in the way of moving a manual foot in the L track. For electric vehicle, use Sika 252 or Sika 255 in a 24-inch section, over the floor stiffening ribs as shown in the figure 3.1 (Page 22) 	

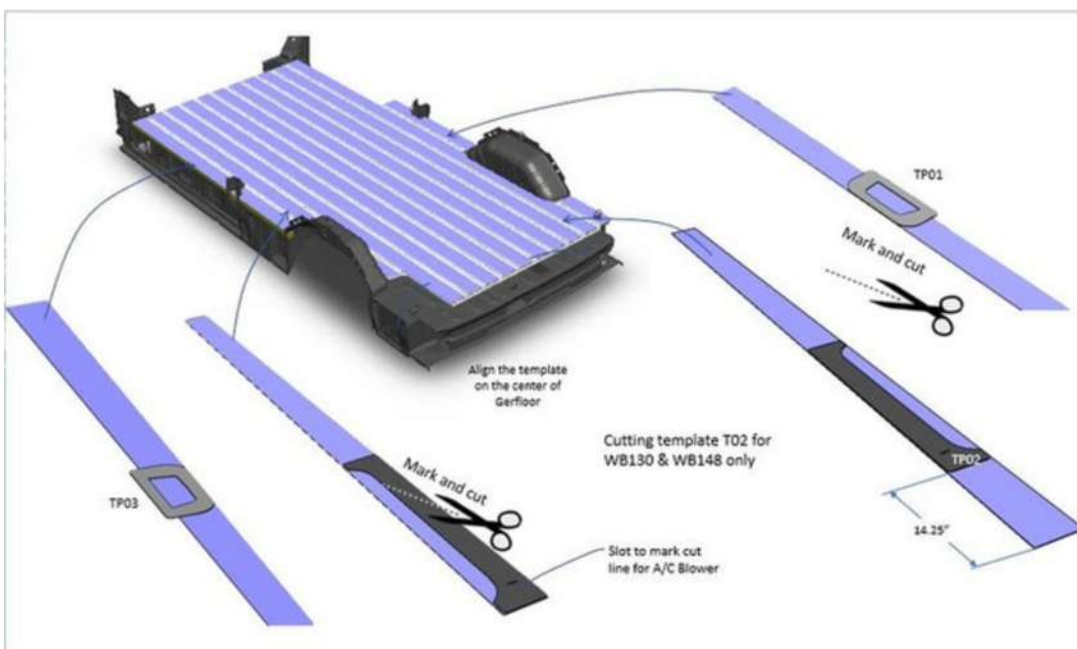
#	Install Step	Description of the steps	Pictures
11	*Optional* Set the Peel and Stick Gerflor	<ul style="list-style-type: none">• Ensure that all foam sides and corner foams are in place before sticking Gerflor• Clean the surface of the panel with rubbing alcohol• Peel the Gerflor and stick it on the floor• Use Gerflor templates to cut the Gerflor for wheel well and C pillar areas• Using scissors instead of knife, to cut wheel well and C pillar area, enable safer, faster and better-perceived quality.	 <p>Align the template on the center of Gerflor</p> <p>Mark and cut</p> <p>TP01</p> <p>TP02</p> <p>14.25"</p> <p>Slot to mark cut line for A/C Blower</p> <p>TP03</p> <p>Mark and cut</p> <p>Cutting template T02 for WB130 & WB148 only</p>

Gerflor is not included in the package

Figure 1.1

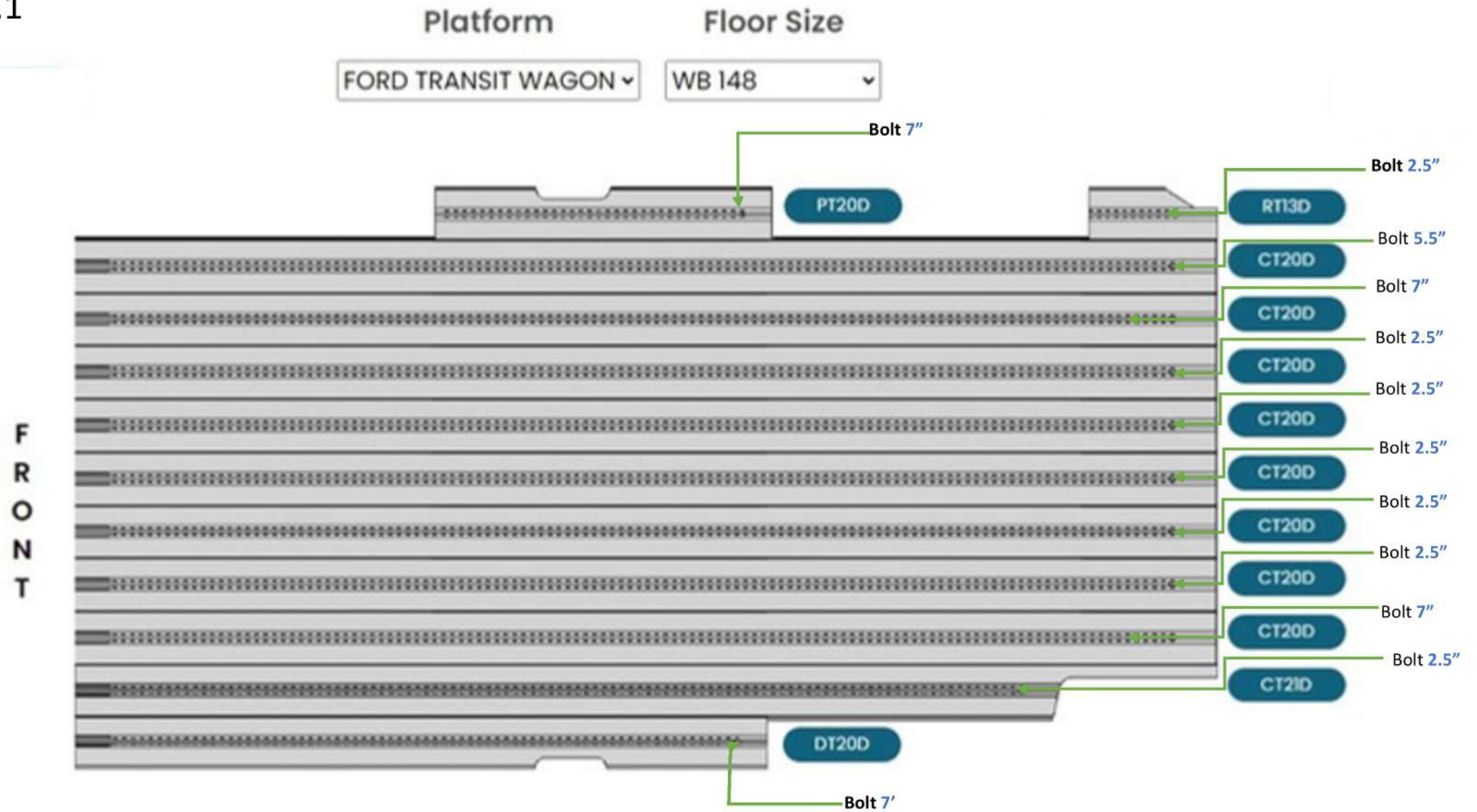

12

Figure 1.2

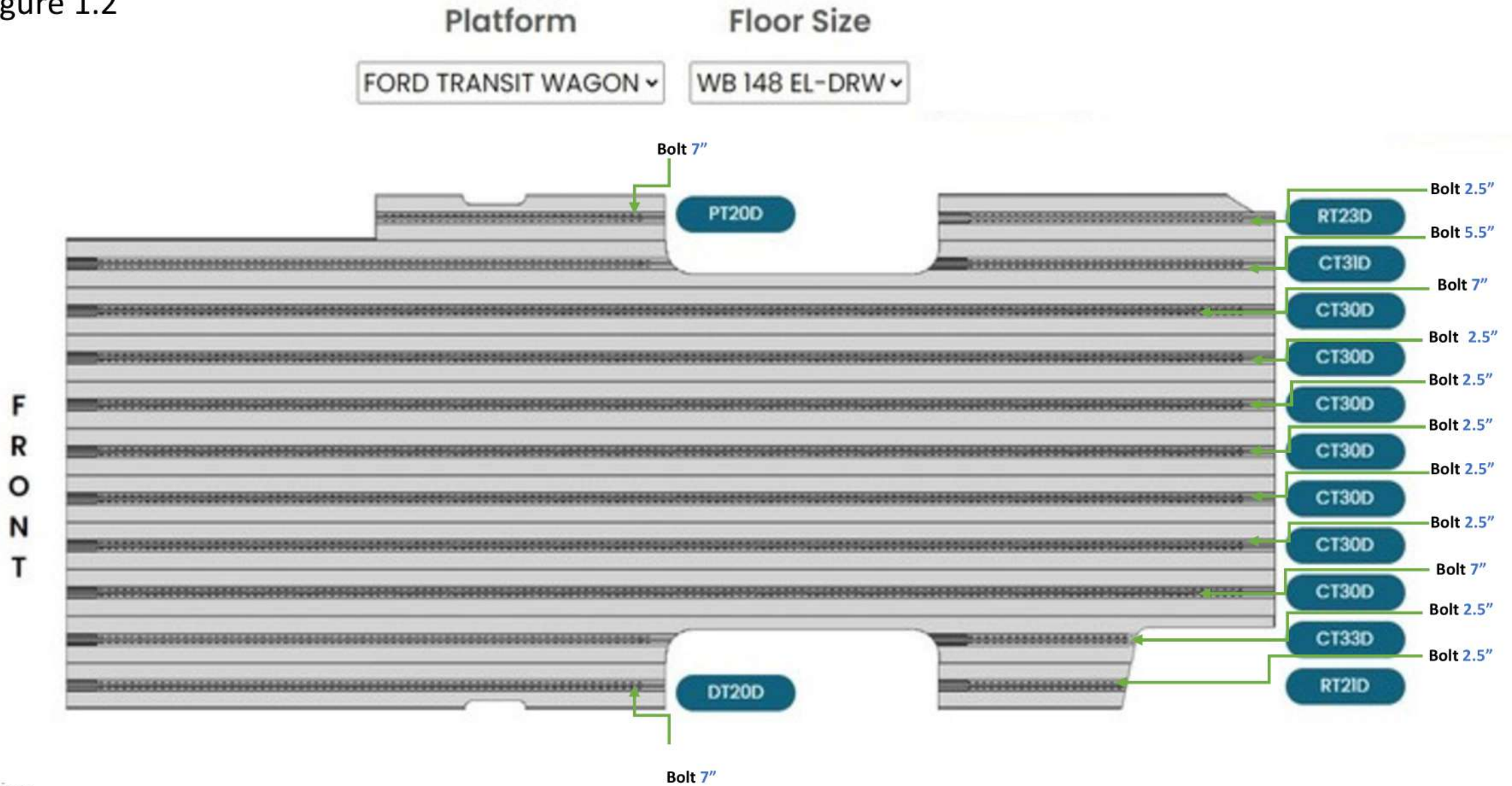

13

Figure 1.3

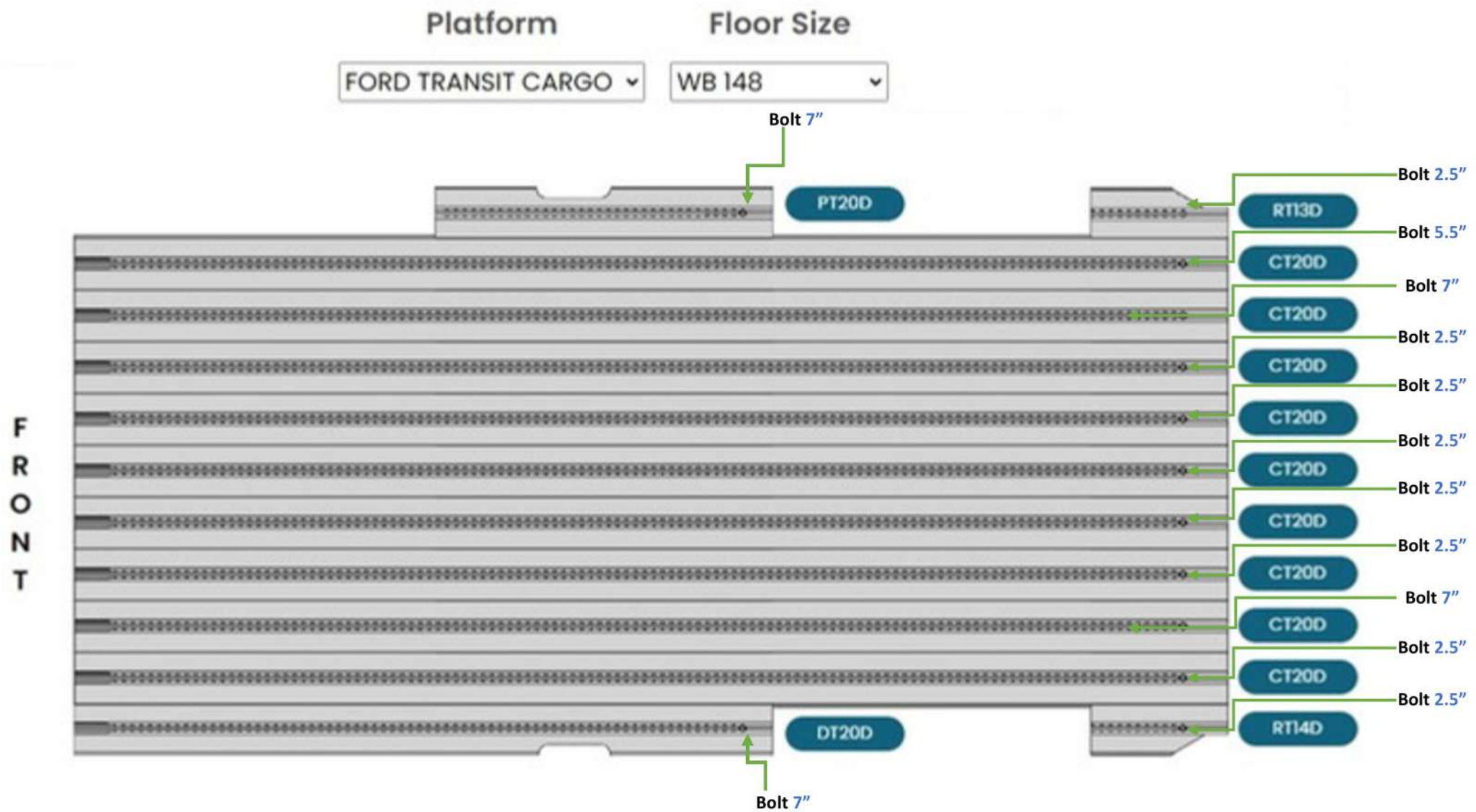

14

Figure 1.4

15

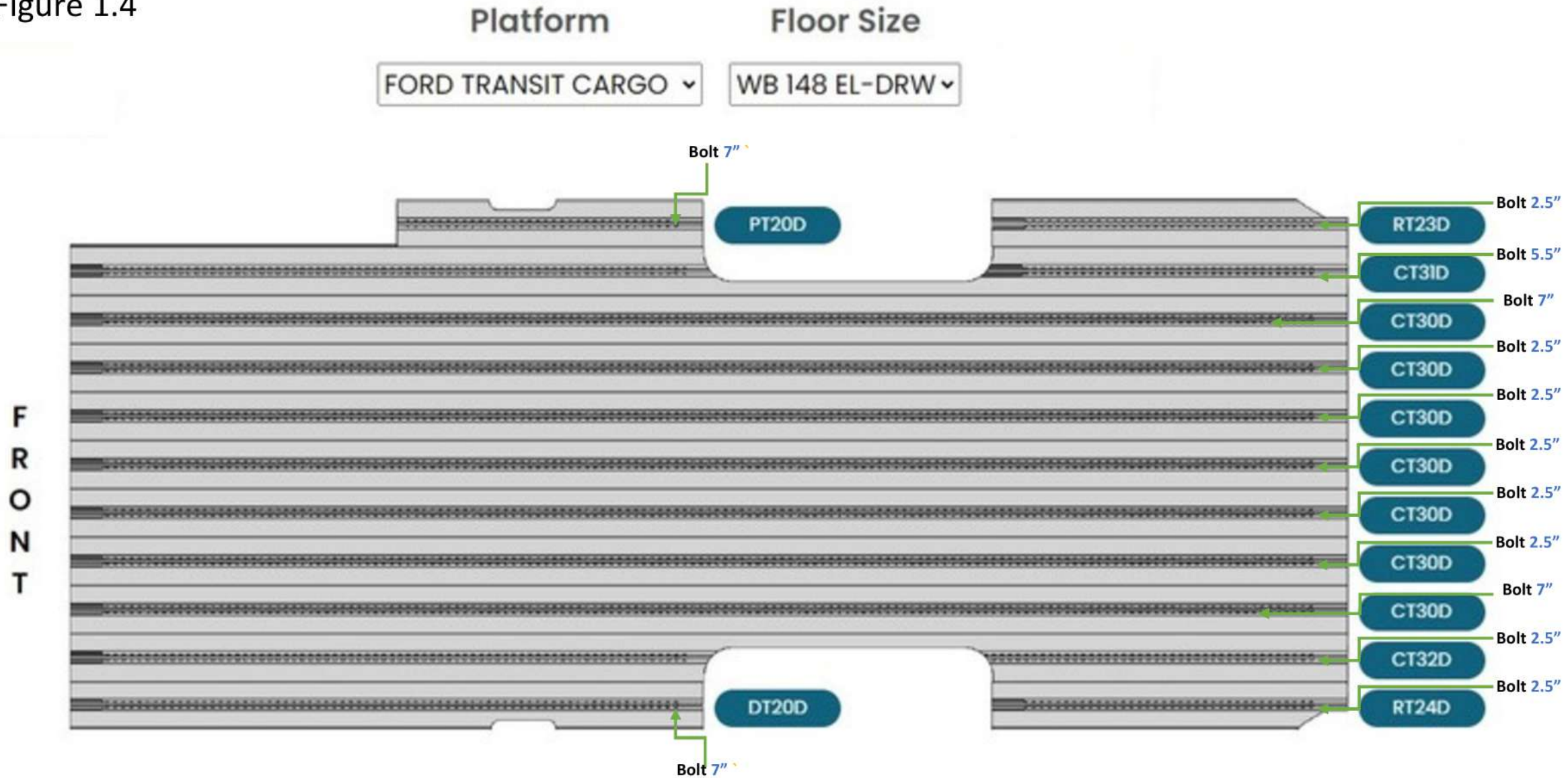
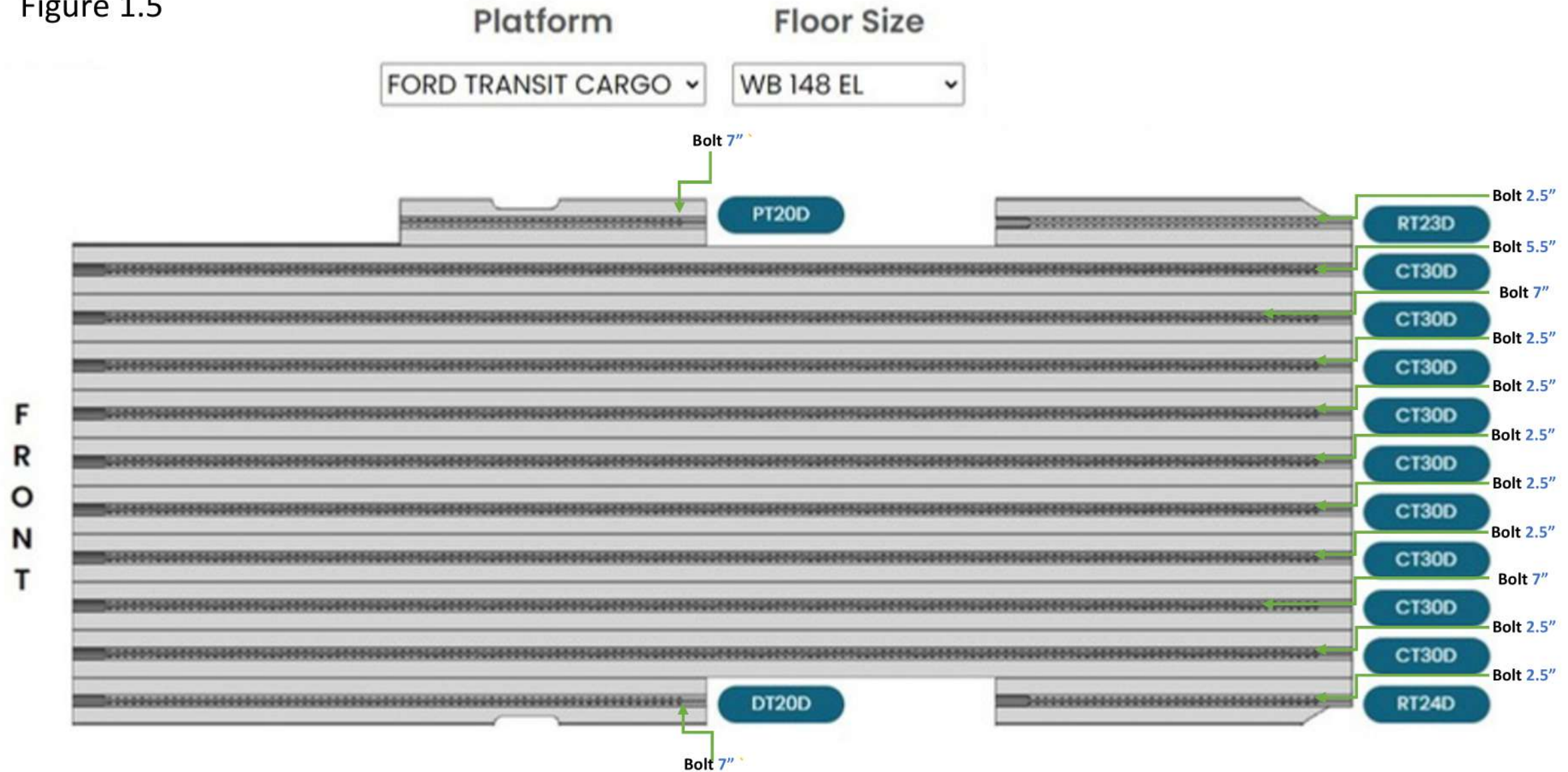
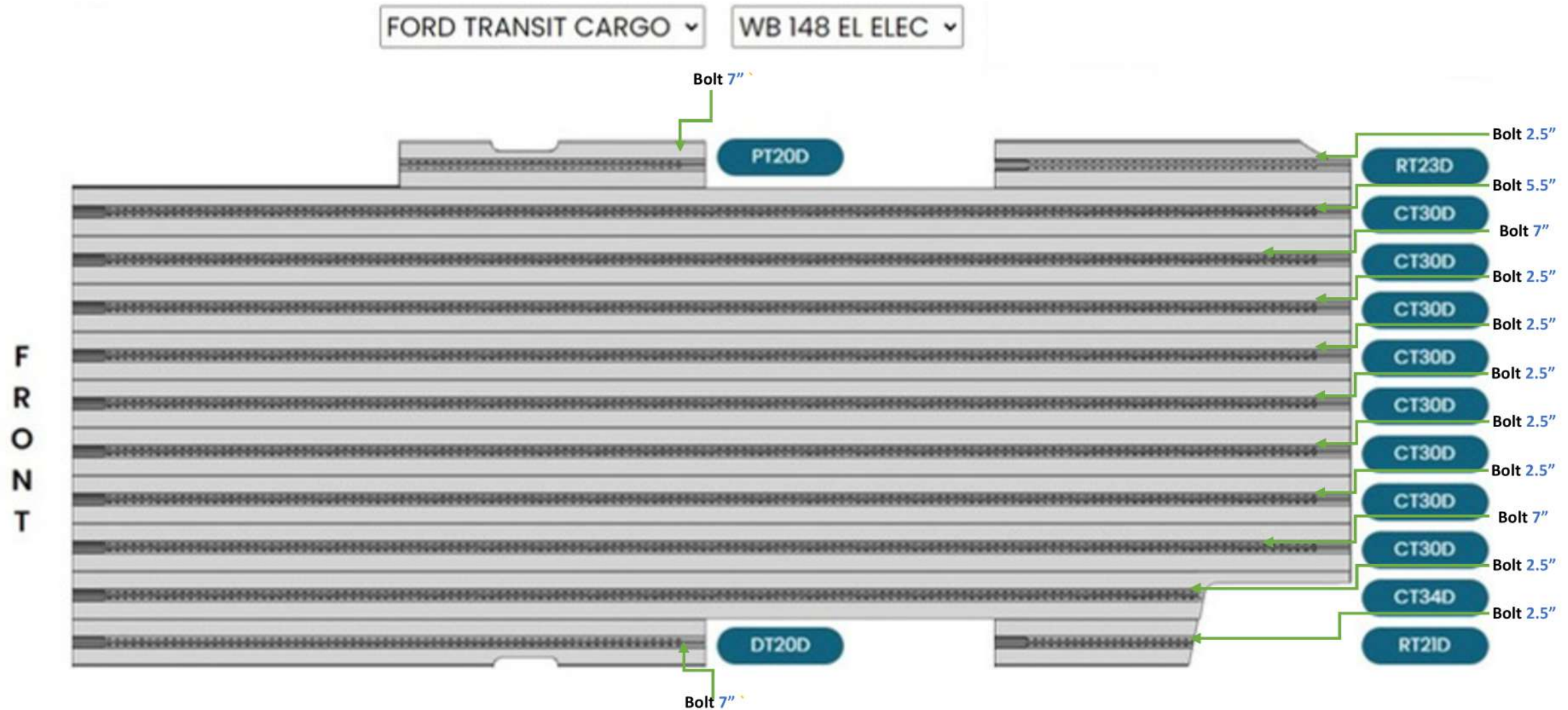

Figure 1.5



16

Figure 1.6



17

Figure 1.7

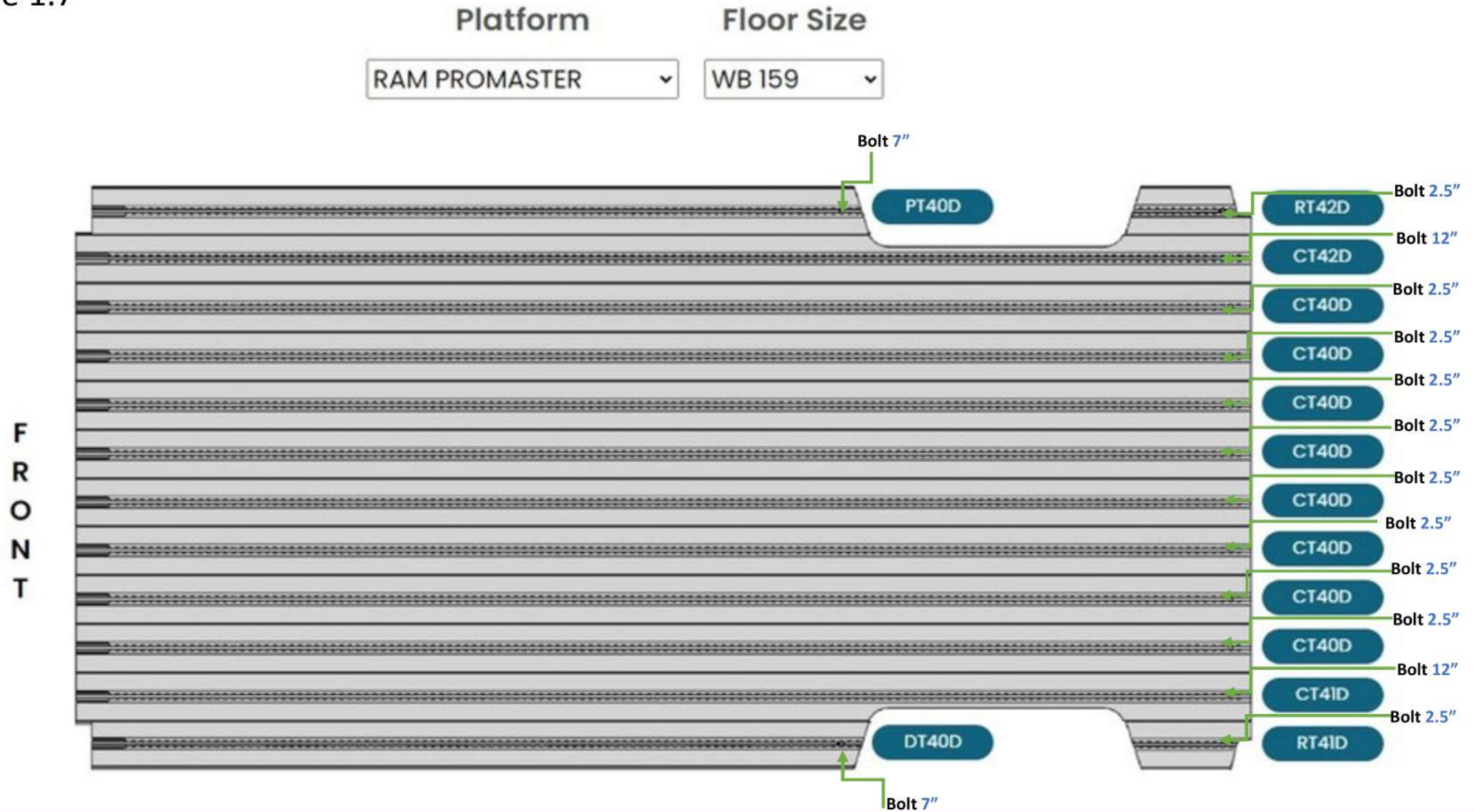

18

Figure 1.8

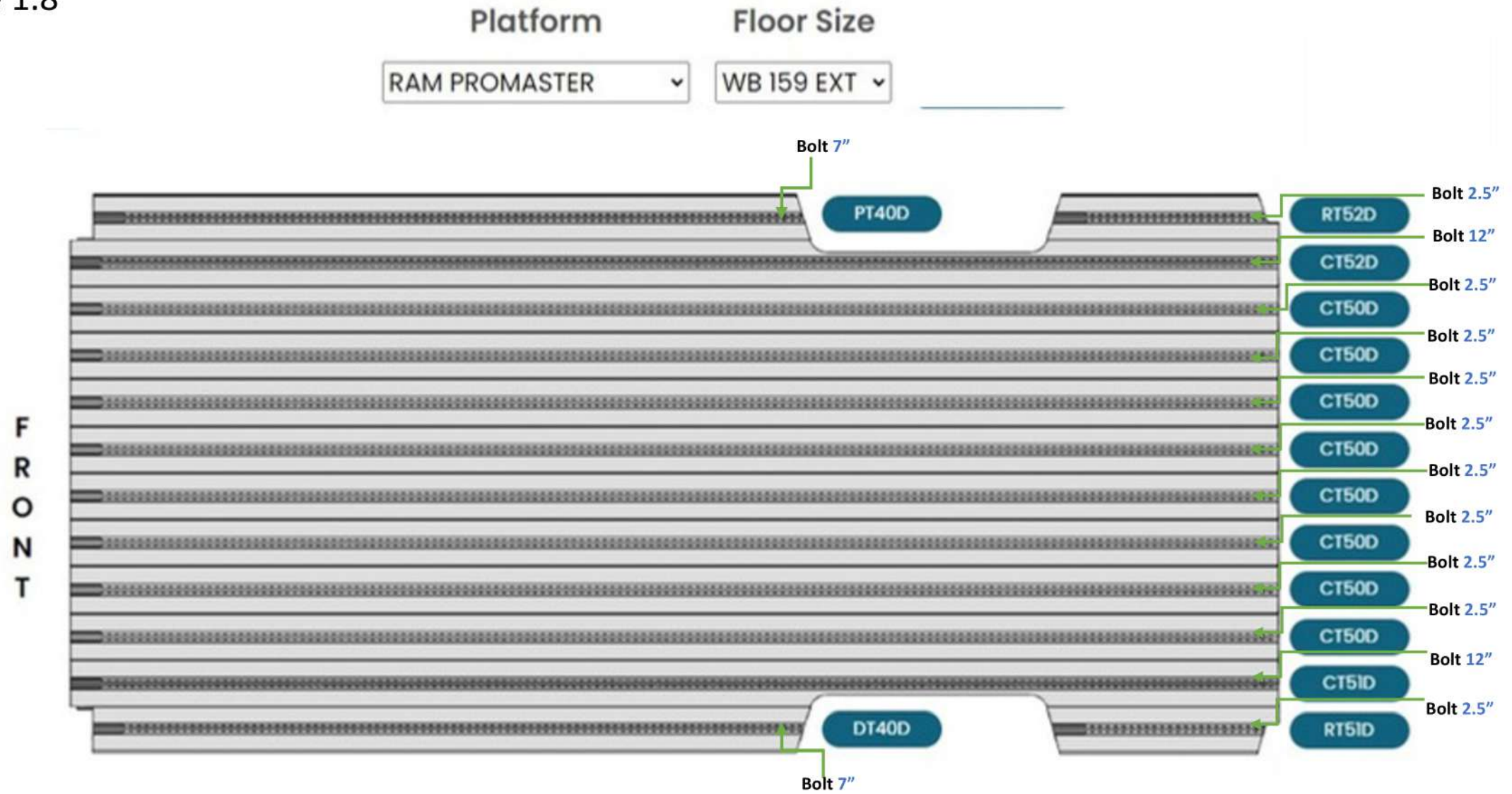

19

Figure 1.9

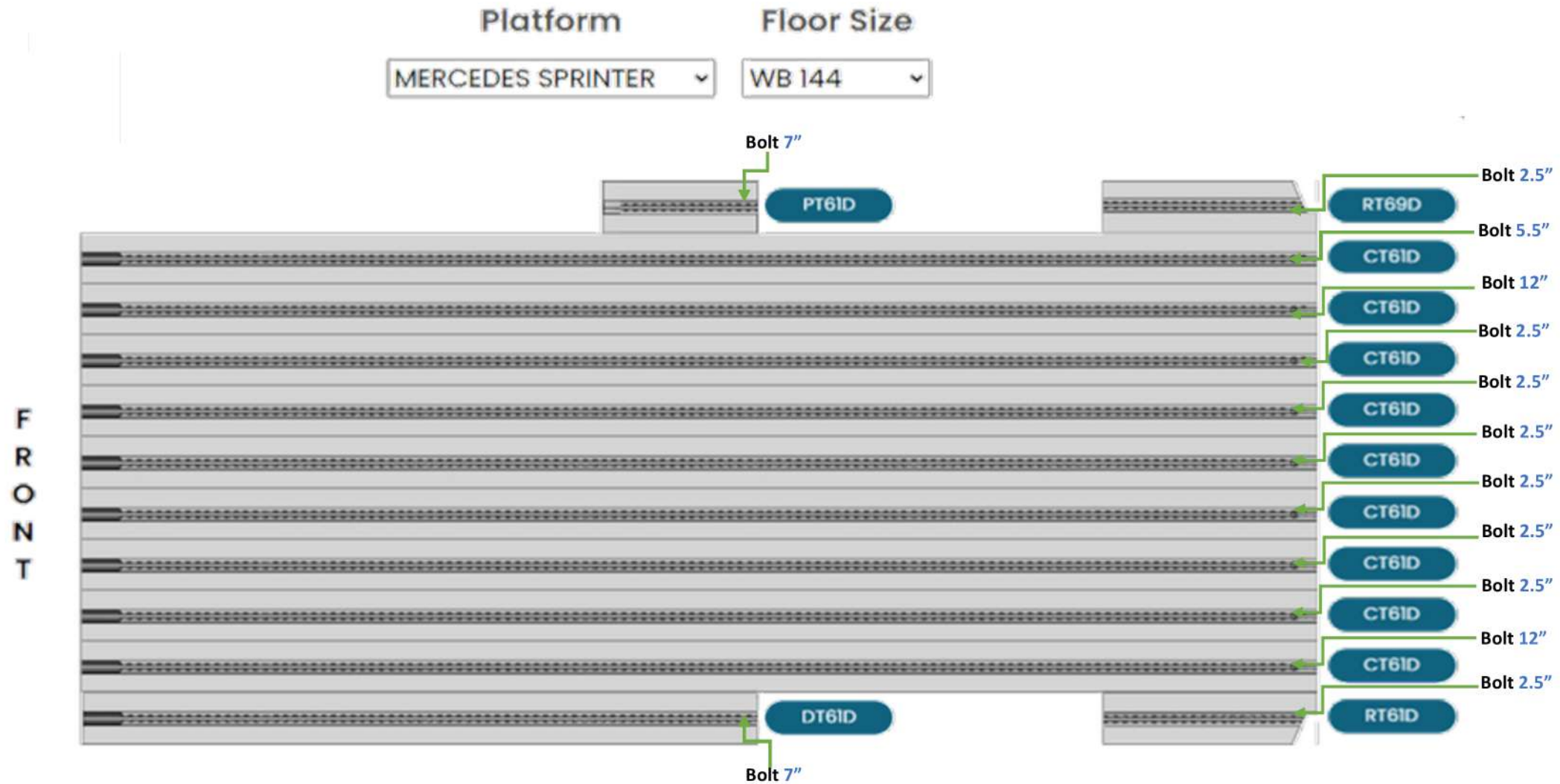
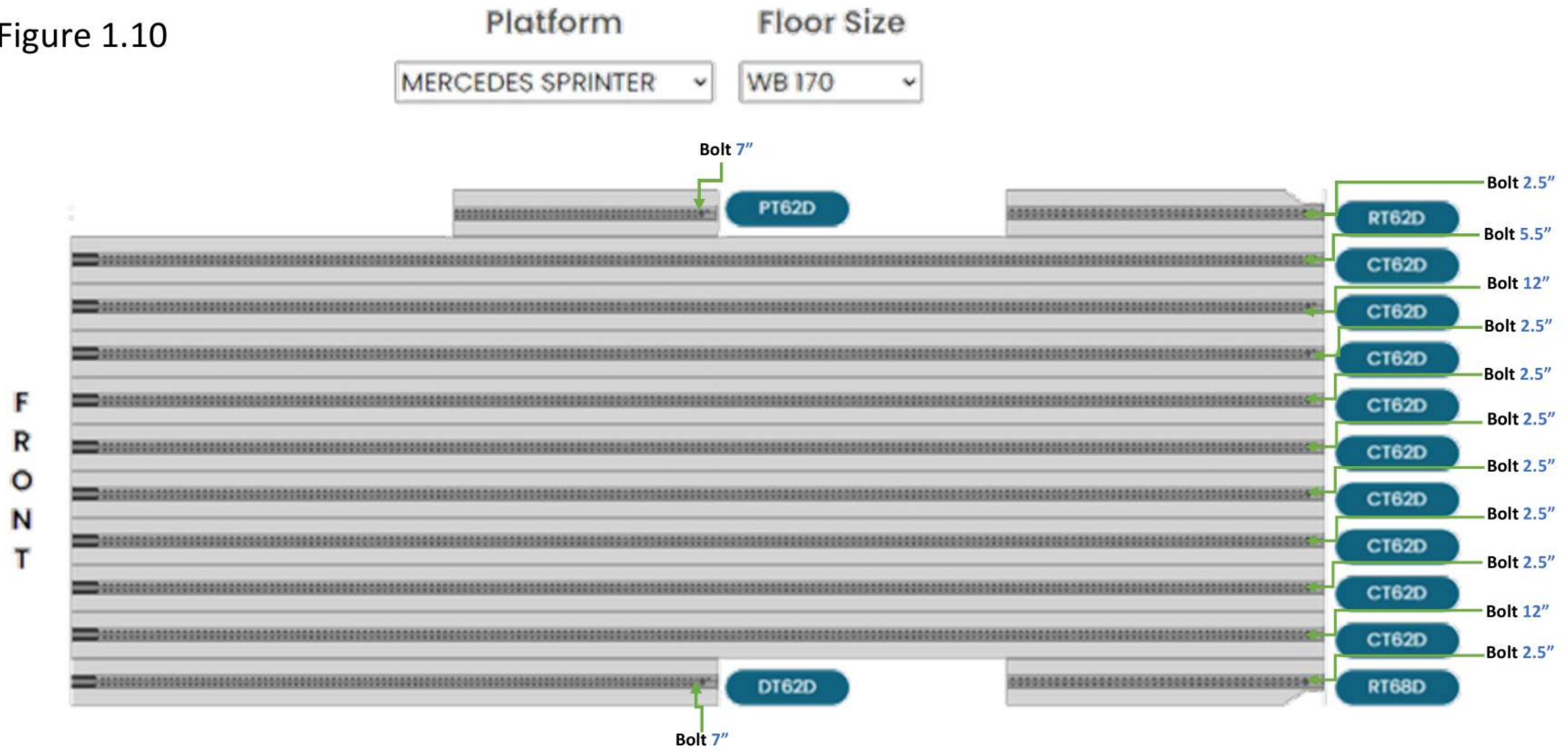
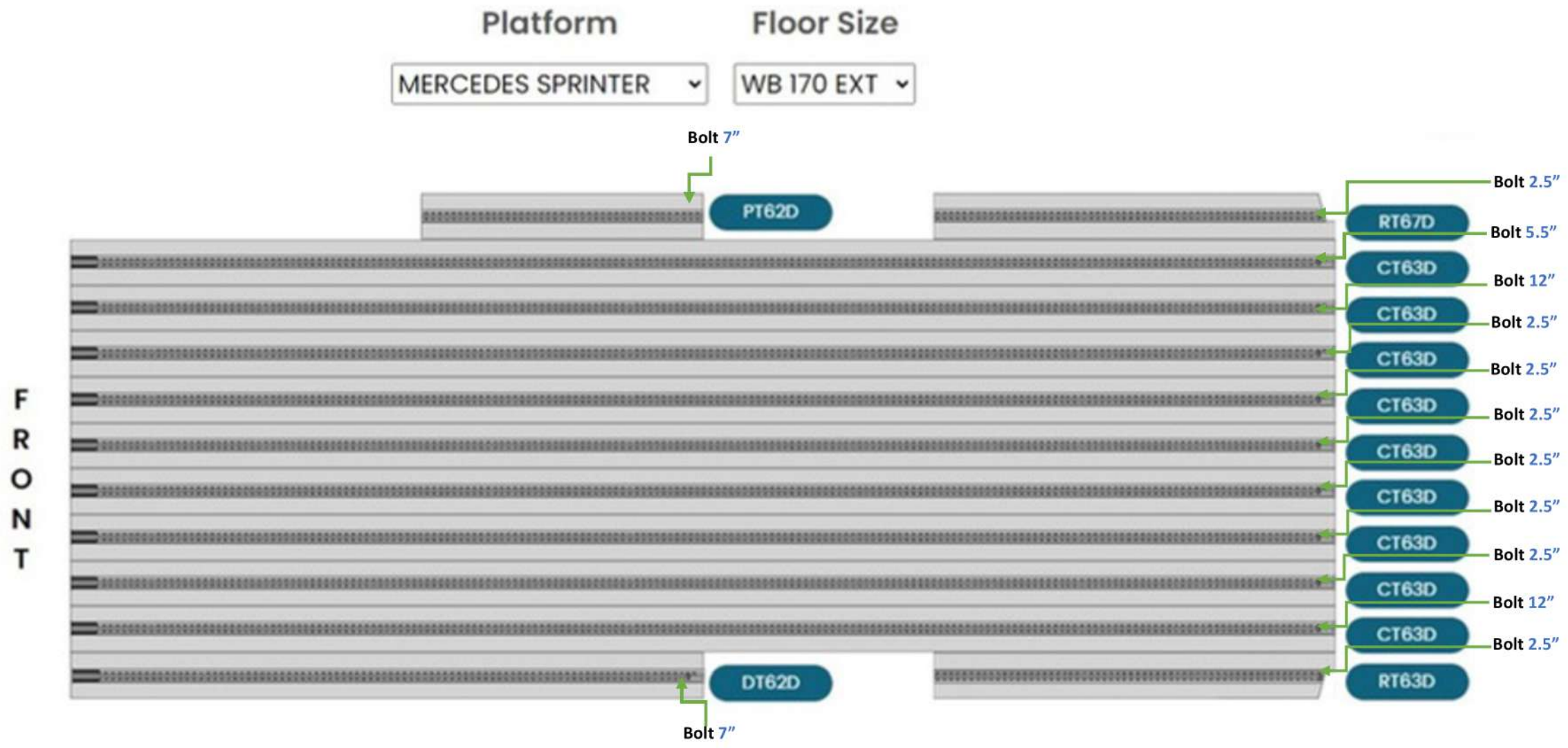

Figure 1.10



21

Figure 1.11



22

Figure 1.12

GMC Savana

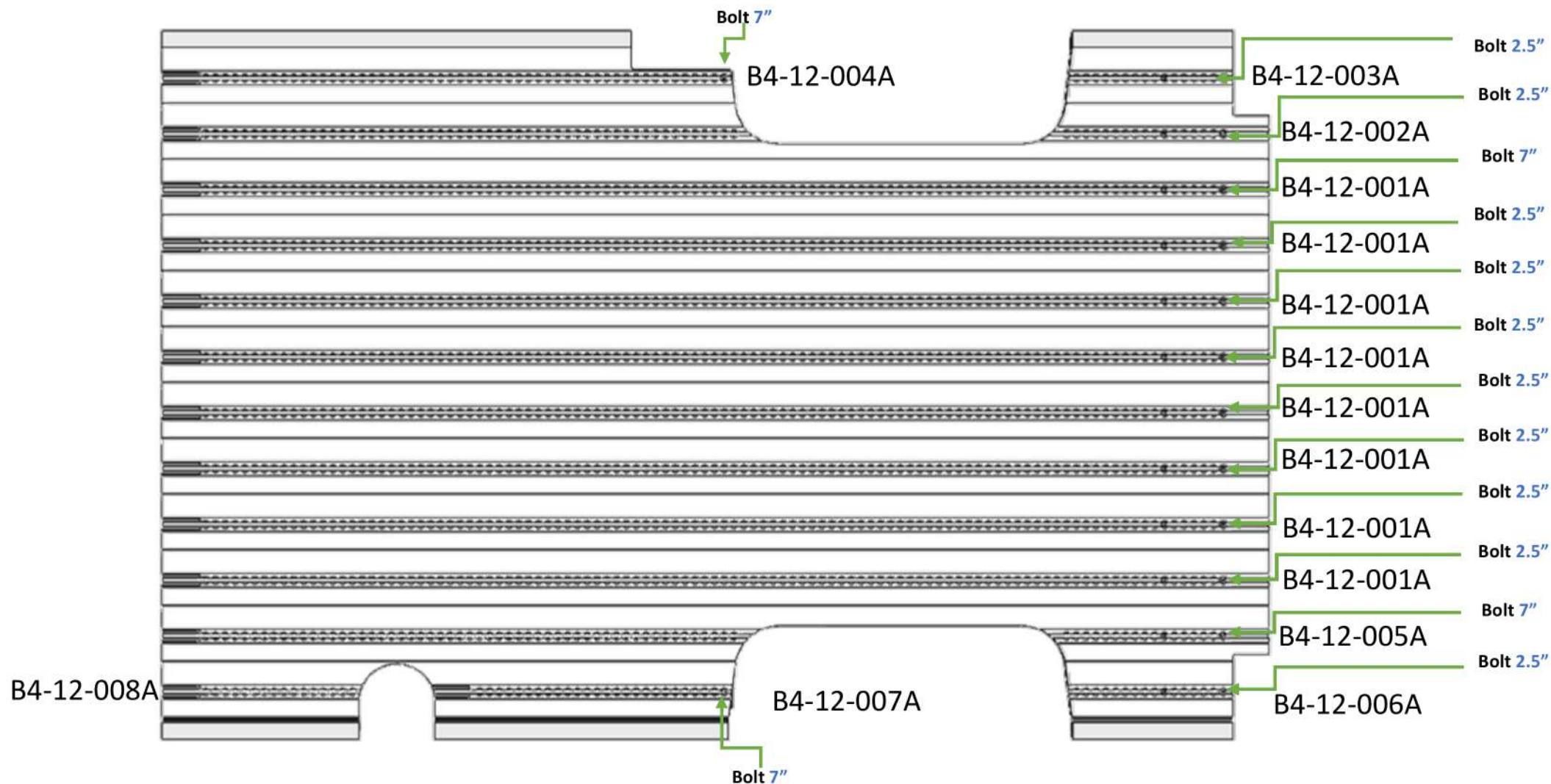

Description of the steps

Figures

Figure 2.1

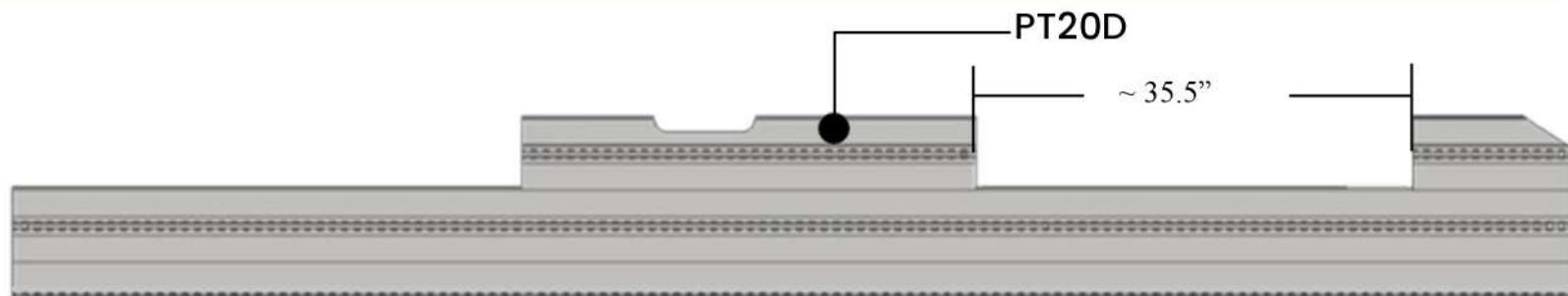

Figure 2.2

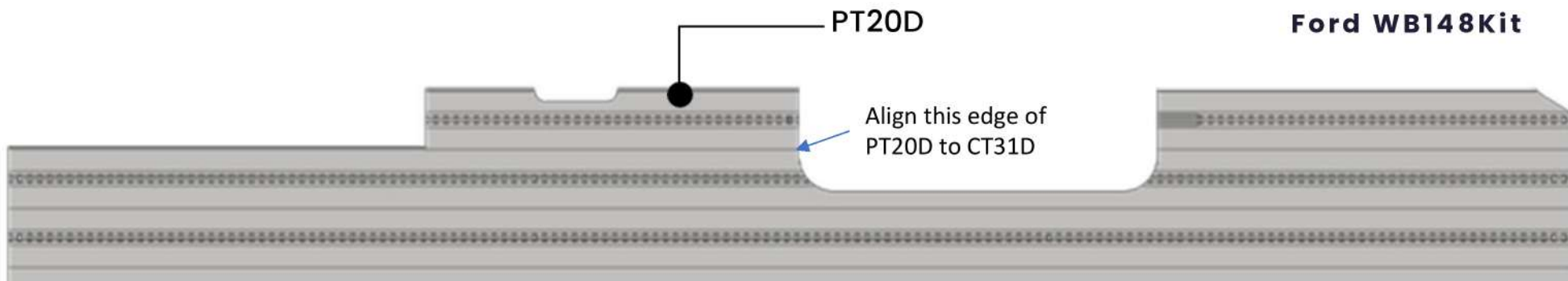
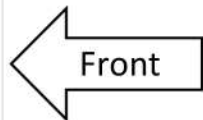
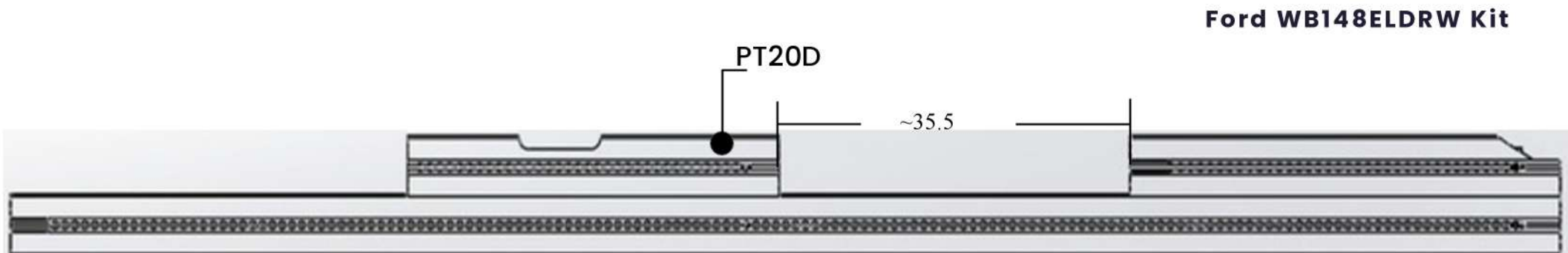

Figure 2.3



P-Panel Alignment

Ford WB148ELKit

Description of the steps



Figure 2.4

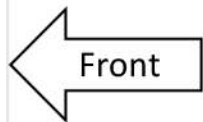
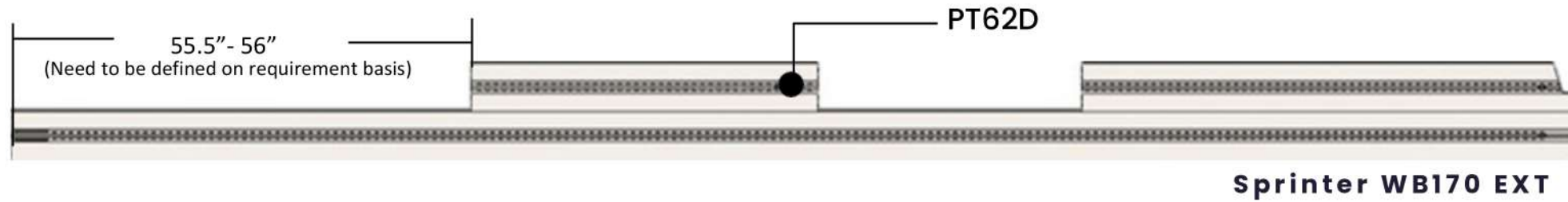
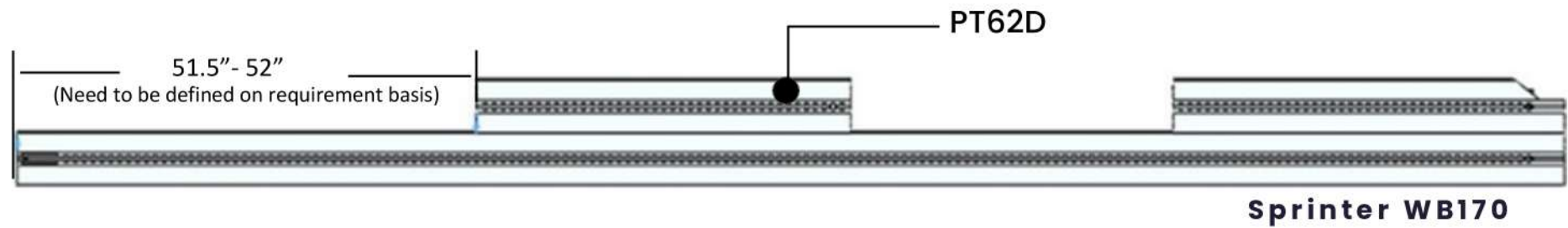

Figure 2.5



P-Panel Alignment

Figure 3.1

Location of the glue over ribs for electric vehicles
24" from the front, Ford WB148 only for reference

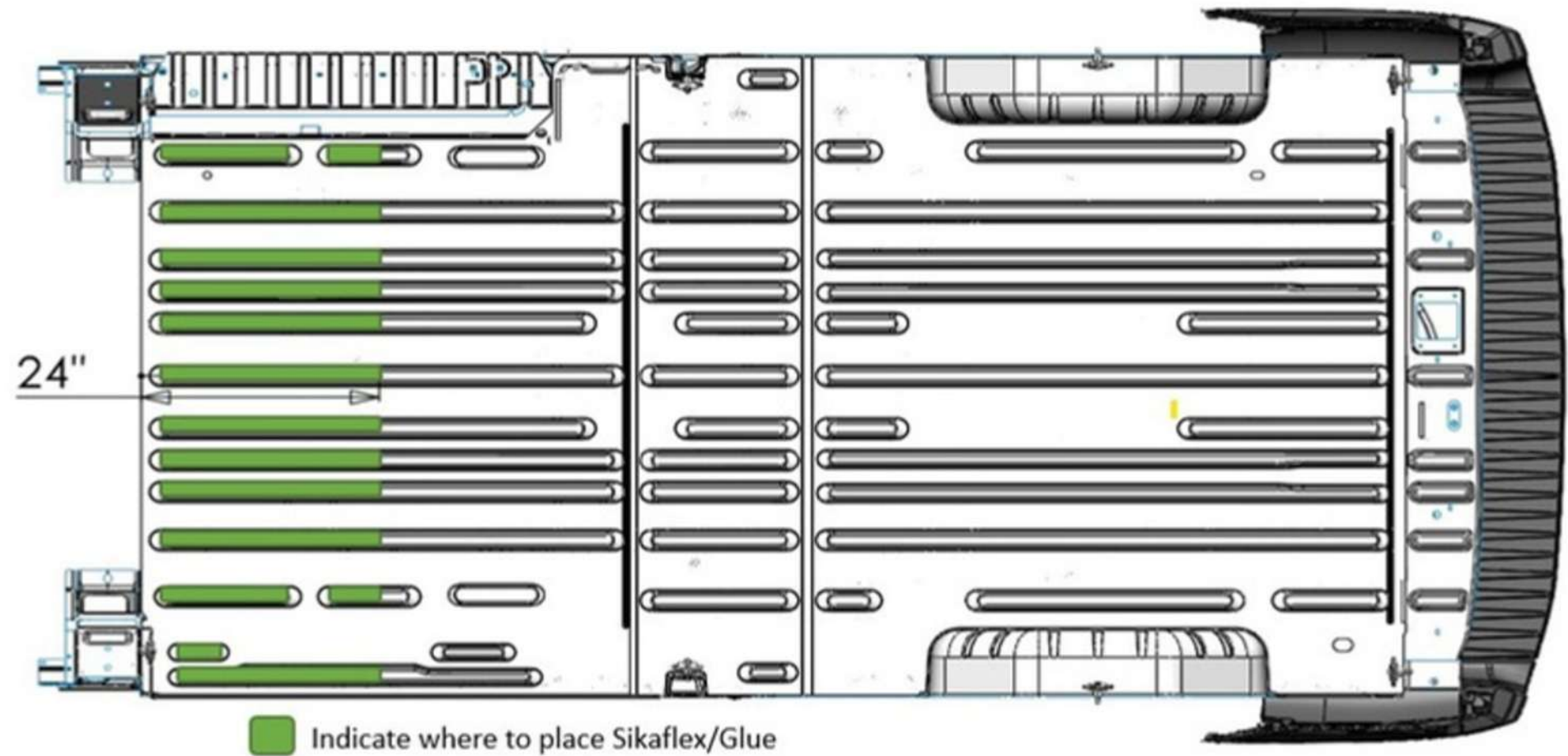

Glue is not included in the package

Only for Ford Transit vehicle

On the 3rd panel from the left and right, move the hole/bolt to 6" forward, for that is clears the bumper structure under the floor

No seats should be bolted in the 6" area highlighted below

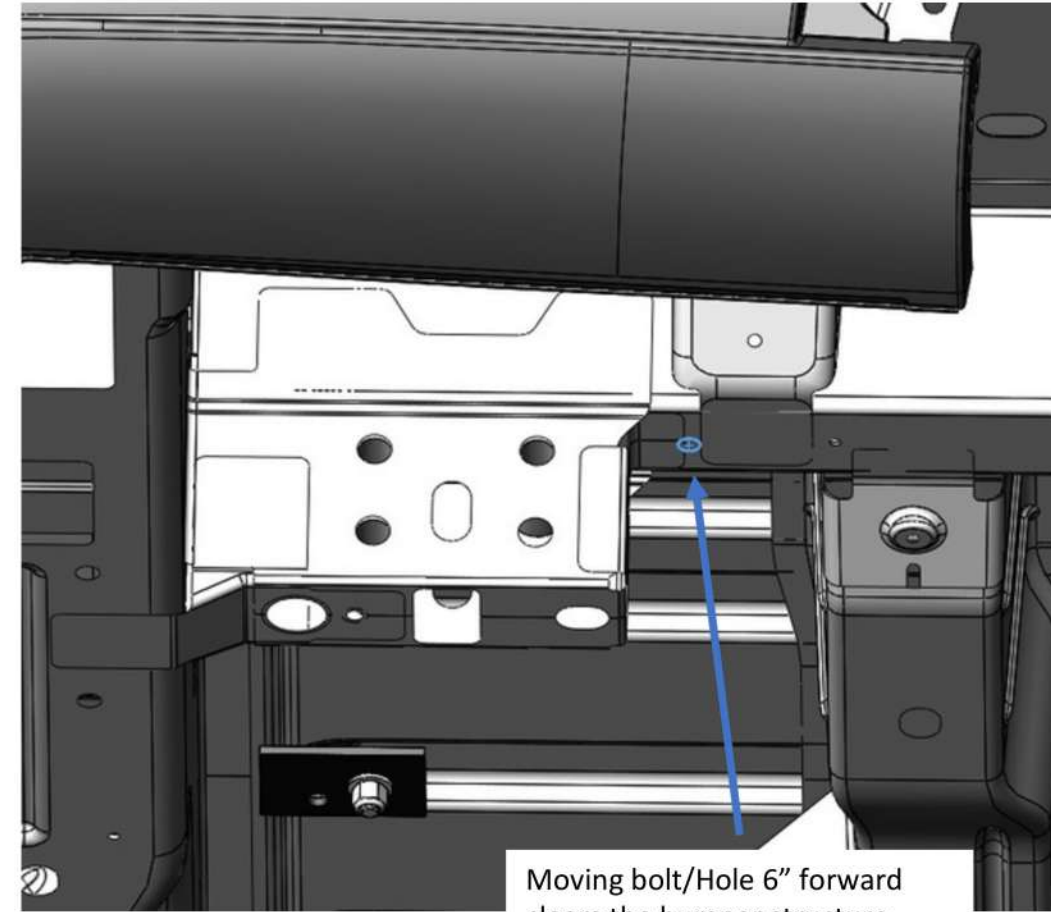
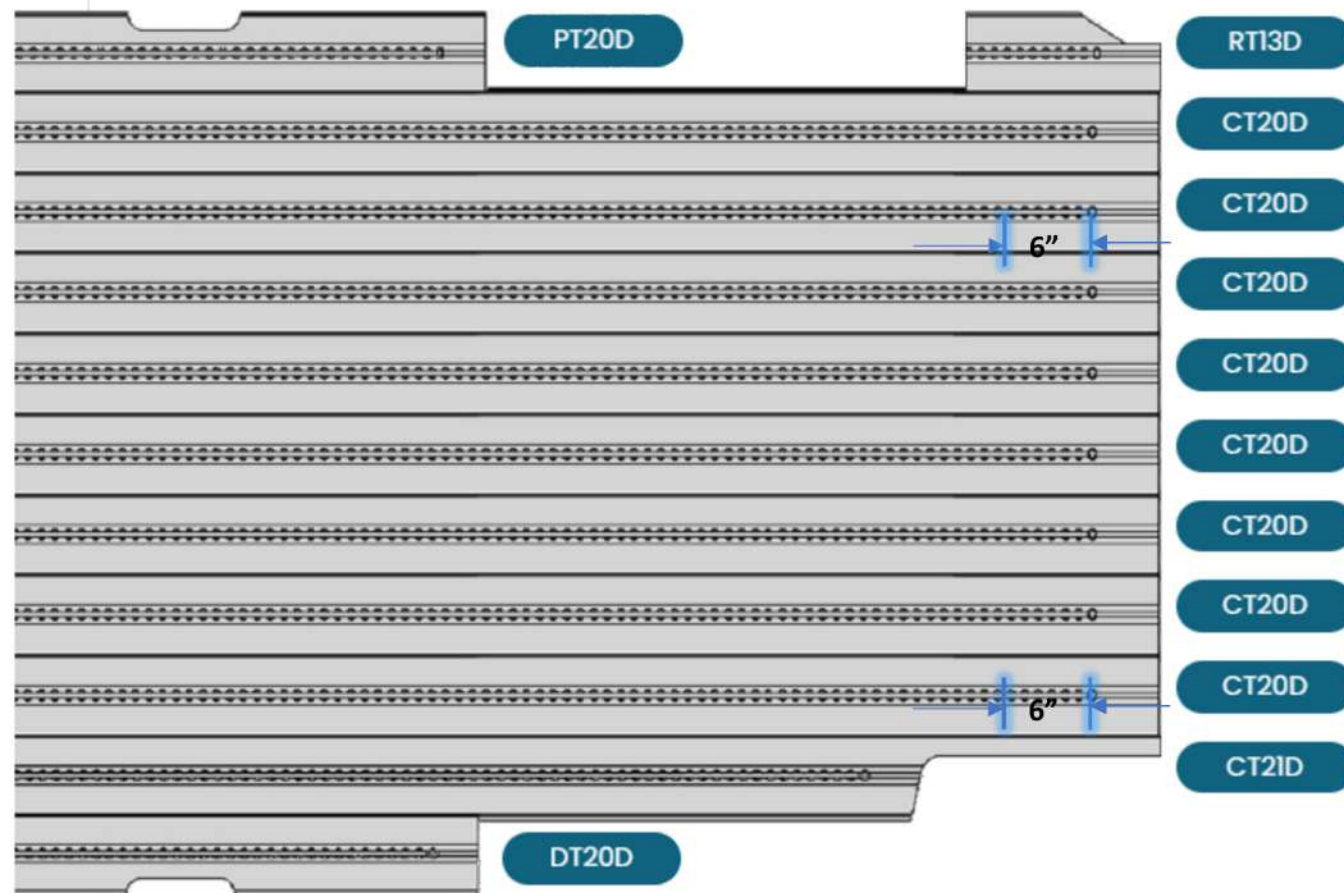

Moving bolt/Hole 6" forward clears the bumper structure